



## **MODULAR CHAIN CONVEYOR SYSTEM**

SISTEMA MODULARE TRASPORTO PALLET A RULLINI  
SISTEMA MODULAR DE TRANSPORTADOR DE CADENA  
SYSTÈME MODULAIRE DE CONVOYEUR À CHÂÎNE  
MODULARES KETTENFÖRDERSYSTEM

EN

**The modular pallet conveyor system is designed to be more responsive to changing market demands. Installation and maintenance are simple and the system can be easily expanded, reconfigured or relocated as your needs change. The system is based on a 3/8" triplex chain with idler rollers Ø15.2 mm.**

**Main advantages offered by this system:**

- **improve productivity;**
- **achieve better product quality;**
- **enhance manufacturing flexibility;**
- **simplify conveyor system development;**
- **reduce overall project cost.**

IT

Il sistema modulare di trasporto pallet è progettato per offrire una risposta più pronta alle richieste di mercato. L'installazione e la manutenzione sono semplici e il sistema può essere facilmente ampliato, riconfigurato o trasferito a seconda delle esigenze. Il sistema si basa su una catena tripla 3/8" con rulli folli Ø15.2 mm.

Principali vantaggi offerti da questo sistema:

- migliorare la produttività;
- raggiungere una migliore qualità di prodotto;
- accrescere la produttività manifatturiera;
- semplificare lo sviluppo dei sistemi di trasporto;
- ridurre il costo globale del progetto.

ES

El sistema modular de transporte de palés está diseñado para ofrecer una respuesta más rápida a las necesidades del mercado. La instalación y el mantenimiento son sencillos y el sistema puede ampliarse, reconfigurarse o trasladarse fácilmente según las exigencias. El sistema se basa en una cadena de rodillos triple 3/8" con rodillos de reenvío Ø15.2 mm.

Principales ventajas ofrecidas por este sistema:

- mejorar la productividad;
- alcanzar una mejor calidad de producto;
- aumentar la productividad manufacturera;
- simplificar el desarrollo de los sistemas de transporte;
- reducir el coste global del proyecto.

FR

Le système modulaire de transport de palettes est conçu pour apporter une réponse plus efficace aux demandes du marché. L'installation et l'entretien sont simples et le système peut être facilement étendu, reconfiguré ou transféré en fonction des besoins. Le système est basé sur une chaîne à rouleau triple 3/8" avec des rouleaux de renvoi Ø15.2 mm.

Principaux avantages offerts par ce système :

- il améliore la productivité ;
- il permet d'obtenir un produit de plus haute qualité ;
- il accroît la productivité manufacturière ;
- il simplifie le développement des systèmes de transport ;
- il réduit le coût global du projet.

DE

Das modulare Palettenfördersystem wurde entwickelt, um eine schnellere Reaktion auf die Anforderungen des Markts zu bieten. Installation und Wartung sind einfach und das System lässt sich problemlos erweitern, neu konfigurieren und entsprechend den Bedürfnissen verlagern. Das System basiert auf einer Dreifach-Rollenkette 3/8" mit Umlenkwalzen Ø15.2 mm.

Wichtigste Vorteile dieses Systems:

- Verbesserung der Produktivität
- Erzielung einer besseren Produktqualität
- Steigerung der Fertigungsproduktivität
- Vereinfachung der Entwicklung von Transportsystemen
- Senkung der Projektgesamtkosten.



**PROFILE FOR Ø95 MM BELTS**

PROFILO PER NASTRI Ø95  
 PERFIL PARA CINTAS Ø95  
 PROFILÉ POUR CONVOYEURS Ø95  
 PROFIL FÜR BÄNDER Ø 95

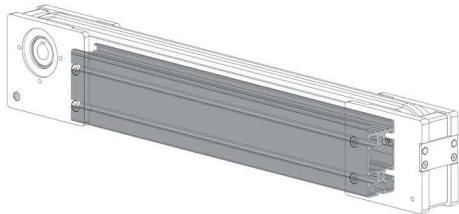

Cod	Note	Kg/m
<b>084.108.002</b>	For 3/8" chain conveyors - Per nastri a rullini 3/8" - Para transportadores de cadena 3/8" - Pour convoyeurs à chaîne 3/8" - Für Kettenförderer 3/8"	3,17

**Anodised aluminium**

Alluminio anodizzato  
 Aluminio anodizado  
 Aluminium anodisé  
 Eloxiertes Aluminium  
**L=6000 mm**

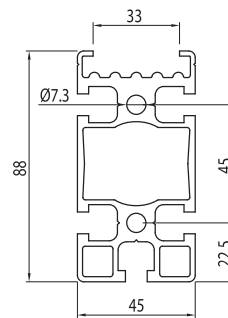

**SLIDING PROFILE**

PROFILO DI SCORRIMENTO  
 PERFIL DE DESLIZAMENTO  
 PROFILÉ DE COULISSEMENT  
 GLEITPROFIL

**NEW**

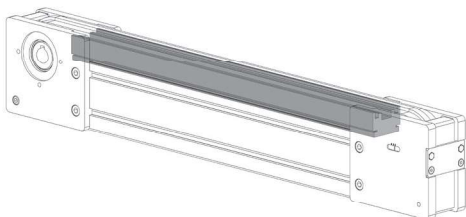
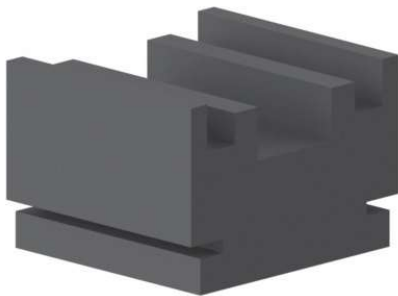

Cod	Note	Kg/m
<b>112.201.001</b>	For 3/8" triplex chain - Per catena tripla 3/8" - Para cadena de rodillos triple 3/8" - Pour chaîne à rouleau triple 3/8" - Für Dreifach-Rollenkette 3/8"	1,1

**Anti-static PE**

Polietilene antistatico  
 Polietileno antiestático  
 Polyéthylène antistatique  
 Antistatisches Polyethylen  
**L=3000mm**

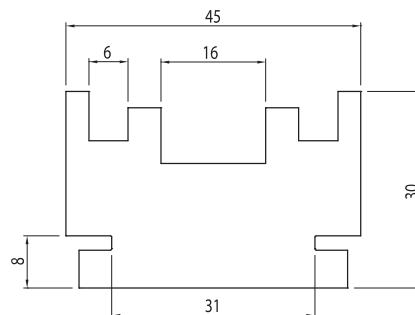



**SLIDING PROFILE**

PROFILO SCORRIMENTO  
PERFIL DE DESLIZAMIENTO  
PROFILÉ DE COULISSEMENT  
GLEITPROFIL

**NEW**

Cod	Note	Kg/m
<b>112.201.002</b>	Per catena tripla 3/8" - For 3/8" triplex chain - Para cadena de rodillos triple 3/8" - Pour chaîne à rouleau triple 3/8" - Für Dreifach-Rollenkette 3/8"	0,23



**Anti-static PE**

Polietilene antistatico  
Polietileno antiestático  
Polyéthylène antistatique  
Antistatisches Polyethylen  
**L=3000mm**

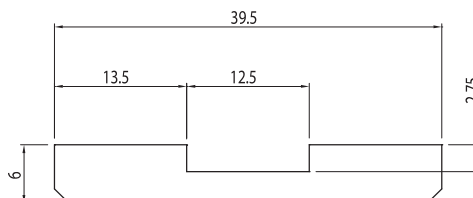
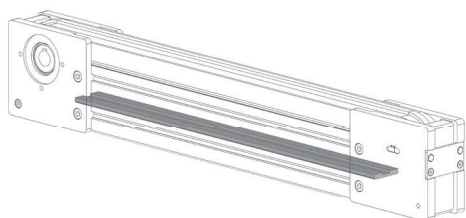

**DIRECT DRIVE**

MOT. DIRETTA  
MOT. DIRECTA  
MOT. DIRECTE  
DIREKTANTRIEB

**NEW**

Cod	Note	Kg
<b>112.200.100</b>	For 3/8" triplex chain - Per catena tripla 3/8" - Para cadena de rodillos triple 3/8" - Pour chaîne à rouleau triple 3/8" - Für Dreifach-Rollenkette 3/8"	1,3



**Aluminium**

Alluminio  
Aluminio  
Aluminium  
Aluminium

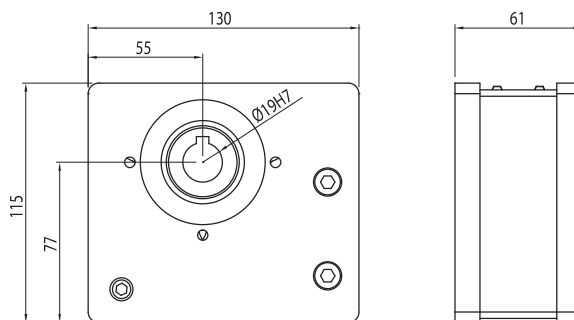
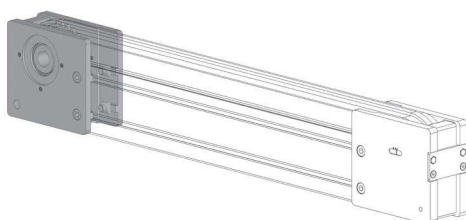



**IDLER**

RINVIO  
REENVÍO  
RENOVI  
VORGELEGEANTRIEB

**NEW**

Cod	Note	Kg
<b>112.200.200</b>	For 3/8" triplex chain - Per catena tripla 3/8" - Para cadena de rodillos triple 3/8" - Pour chaîne à rouleau triple 3/8" - Für Dreifach-Rollenkette 3/8"	1,2



**Aluminium**

Alluminio  
Aluminio  
Aluminium  
Aluminium

